













Ref. 2RH20PVSAQT0000000

DATOS TÉCNICOS

 21 KW	 1,8 - 4,1 Kg/h	 hasta 561 m ³	
 17,9 KW	 120 M mm	 18 Kg	
 91%	 230 V	 118 Kg	 702 x 600 x 613 mm

CARACTERÍSTICAS

- Salida de humos: Superior;
- Estufa con dimensiones estándar para la mayoría de chimeneas construidas;
- Fácil de instalar, utilizar, encender y mantener;
- Estructura de chapa de acero reforzada;
- Regulación del aire de combustión mediante válvula de fácil accionamiento;
- Funcionamiento estanco posible conectando el aire de admisión directamente desde el exterior;
- Sistema SMARTSTOVE incluido:

Termostato inalámbrico con conexión de hasta 10 metros 

Aplicación 4Heat para gestión remota 

Receptor Pinkey 

Controla su **Aquatek** desde el teléfono



Termostato



App 4Heat

FUNCIONALIDADES



OPCIONAL

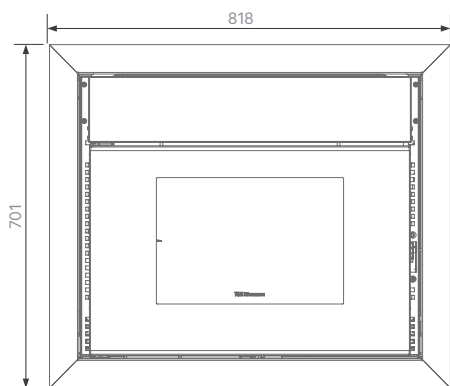

VISTA FRONTAL

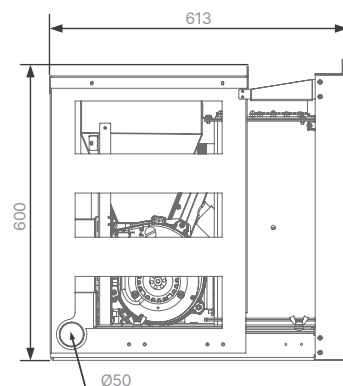

VISTA LATERAL

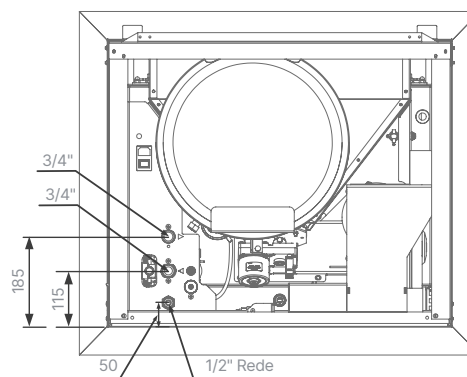



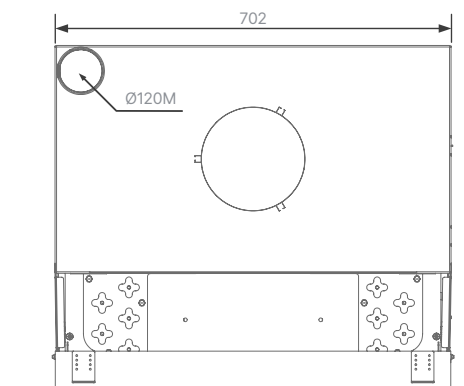









VISTA TRASERA



VISTA DE ARRIBA

DATOS TÉCNICOS

-  |  21 KW
-  1,8 - 4,1 Kg/h
-  hasta 561 m³ 
-  17,9 KW
-  120 M mm
-  18 Kg
-  91%
-  230 V
-  118 Kg
-  702 x 600 x 613 mm



SISTEMAS HIDRÁULICOS CH

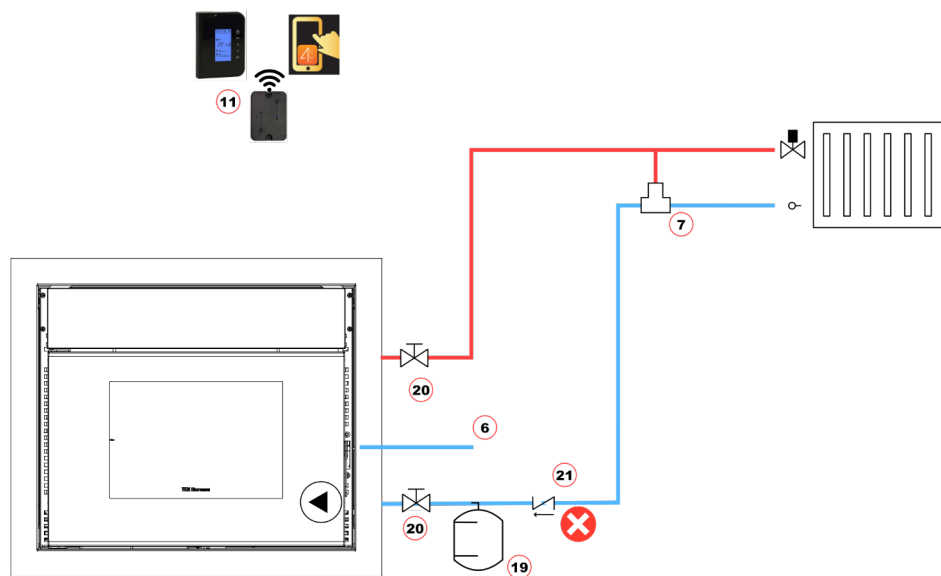

CH + ACS

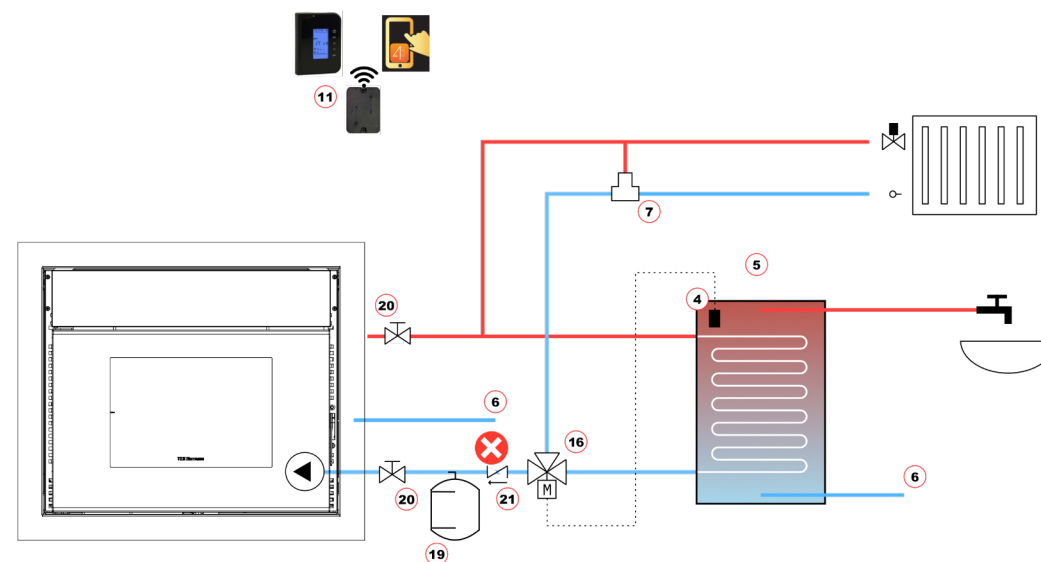

LEYENDA

- | | | |
|--|--|---|
| 4 Sensor de temperatura con termostato 0°C - 90°C | 7 Válvula mezcladora termostática | 19 Vaso de expansión adicional* |
| 5 Depósito de ACS | 16 Válvula de 3 vías | 20 Válvula de seccionamiento |
| 6 Red de suministro | 11 Termostato a distancia + APP | 21 No instale una válvula antirretorno |

*Calcule el volumen total de expansión de la instalación para comprobar la necesidad real de un vaso de expansión. Simulador en www.tekbiomasse.com